



FPS-200 Flat Panel Motorized Lifting Mount Series

ITEM: FPS-200



WEIGHT CAPACITY:
250 LB / 113.6 KG

FEATURES

- 1 Works with interactive display panels
- 2 Motorized lifting and lowering system with 18" of adjustment
- Integrated cable management
- Great option for educational use in the classroom or corporate training
- VESA mounting patterns

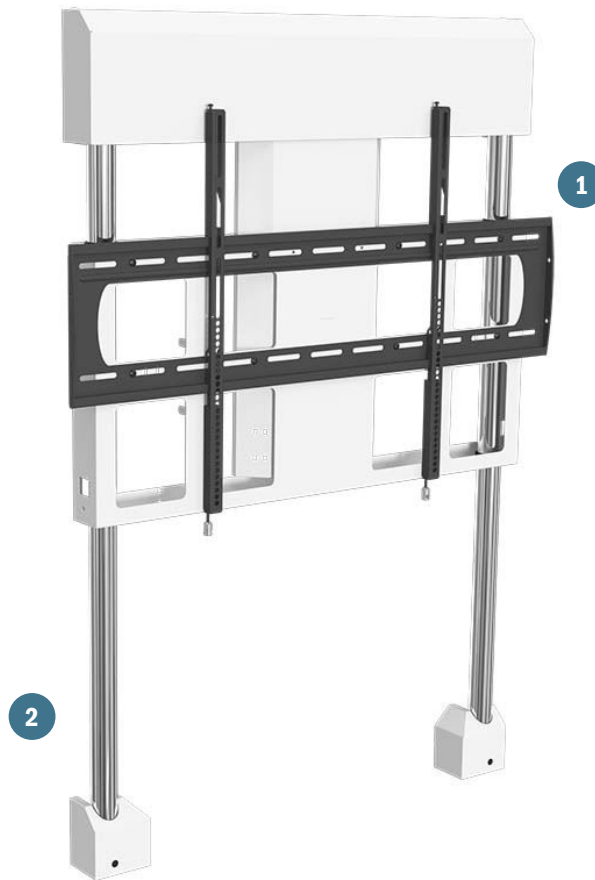
The FPS Flat Panel Lifting Mount series provides a simple stationary or mobile wall mounted unit that utilizes a motorized lifting and lowering system to help gently guide the display to the desired height. Mounting over the top of a whiteboard, the FPS Series can be easily adjusted to the desired vertical position and provide a great tool for interactive presentations or classroom learning environments.



		
FPS series offers motorized lift and lower with 18" of adjustment	Easy remote controlled access to adjust panel to desired height	FPS-EXT Extension Kit available to expand track to any desired length



FPS-200 Flat Panel Motorized Lifting Mount Series

SPECIFICATIONS

COLOR	WEIGHT CAPACITY/MOUNT	MOUNTING PATTERN
White	250 lb. 113.6 kg	200 x 200 mm (Min) x 600 x 400 mm (Max)
WIDTH x HEIGHT x DEPTH	TOTAL WEIGHT CAPACITY	WARRANTY
FPS-200 45.21 x 62.99 x 4.89 in. 1148.3 x 1600 x 124.1 mm	250 lb. 113.6 kg	Lifetime

ACCESSORIES

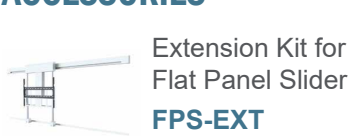

ARCHITECTURAL DRAWING

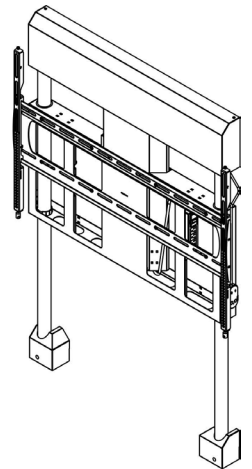
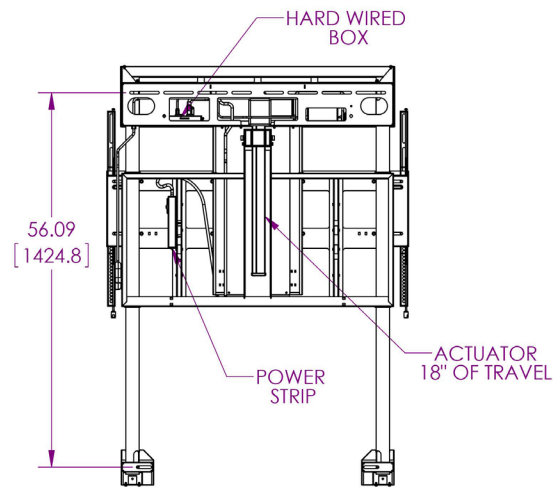
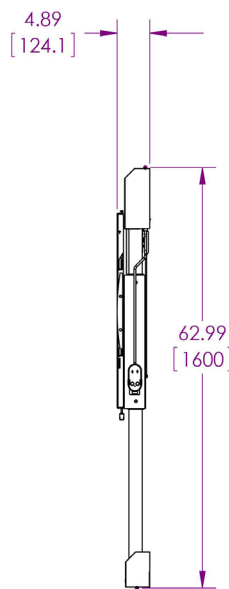
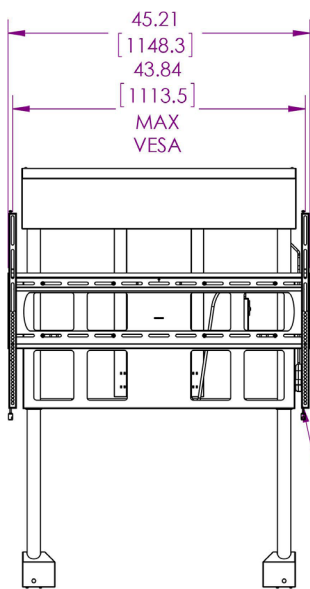
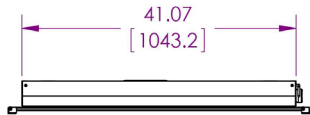

LATERAL ADJUSTMENT VIA MOUNTING BRACKETS