

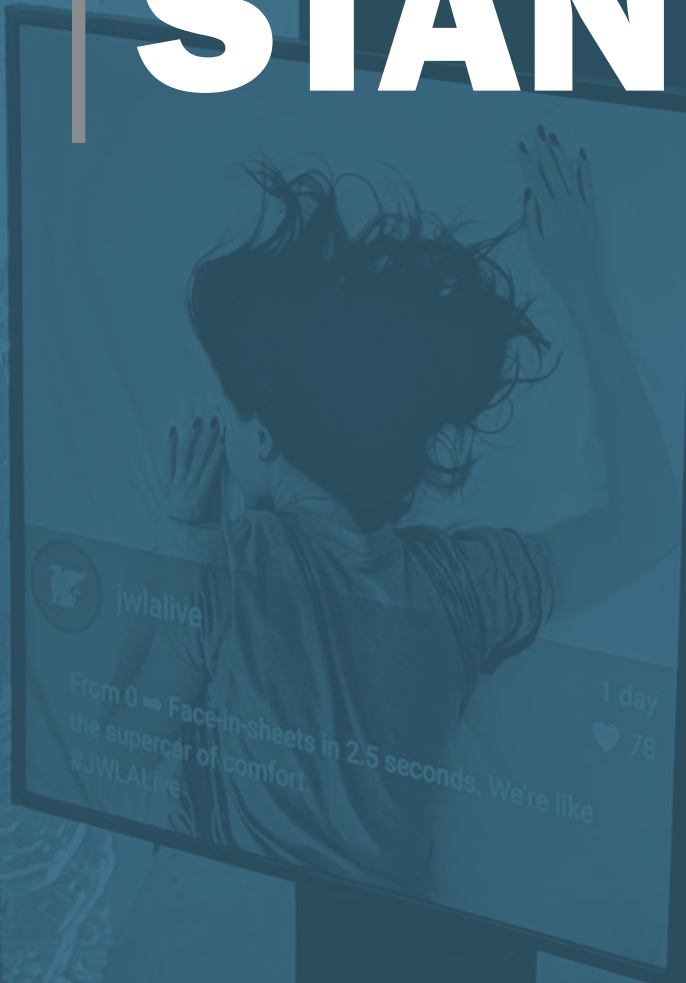

# CARTS & STANDS



# FEATURES

- Lightweight and Heavy-Duty Bases available
- Mix and match individual parts based on your project needs
- Mount adapters included to attach display mount to poles
- Route cables through chrome or black powder-coated poles
- Post-installation accessories available



## CORPORATE

Carts & stands are used in boardrooms, training rooms, corporate lobbies, on the manufacturing floor or at company meetings.

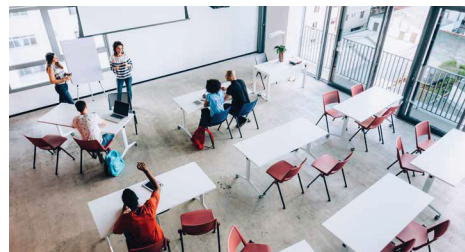

## EDUCATION

Carts are a standard piece of furniture in classrooms and auditoriums today. From K-12 to colleges and universities equipment needs to be moved from classroom to classroom, auditoriums and lecture halls need the mobility to arrange A/V equipment based off of the type of lecture or event.

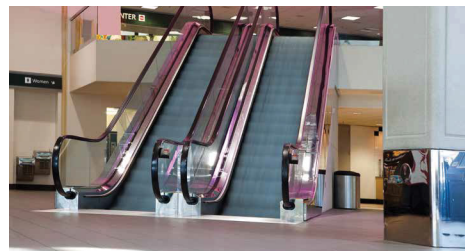

## HOSPITALITY

In hospitality, a great deal of flexibility is needed to accommodate the ever-changing needs of the venue, as well as the fast-paced event and conference on a daily basis.

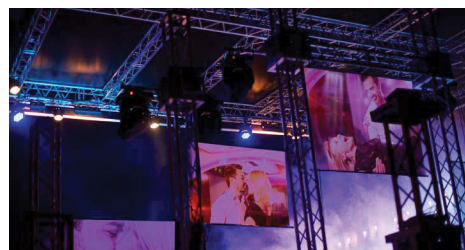

## EVENTS

Organizers of outdoor events, concerts, and trade shows rely heavily on carts and stands. The equipment must be tough and durable in order to withstand the strains of transportation, set-up, take-down, and environmental conditions.



### 1. THE BASE

All bases, poles and mounts are interchangeable and may be re-configured by the customer.

### 2. THE WHEELS

Durable 3" or 4" polyurethane are available to mobilize your display stand.

### 3. THE POLES

Poles are available in different lengths and finishes.

### 4. THE MOUNT

Every cart or stand needs a flat-panel mount. Choose from a selection of fixed, tilting, or rotating mounts.

### 5. ACCESSORIES

To make a stand or cart complete, add an equipment or camera shelf or literature holder.

# PRODUCT SELECTION

## BASES



**TL-BASE**

Lightweight, portable Dual-Pole Floor Stand Base with PSD-HDCA Adapter  
Load Rating: 160lbs. | 72.5kg



**TS-BASE**

Heavy-Duty, Low-Profile Dual-Pole Floor Stand Dual-Pole Floor Stand  
Load Rating: 200lbs. | 90.7kg



**CS-BASE**

Dual-Pole Floor Stand Base for Back-to-Back Display Configurations  
Load Rating: 160lbs. | 72.5kg



**EB-BASE**

Elliptical Floor Stand Base  
Load Rating: 200lbs. | 90.7kg



**BW-BASE**

Dual-Pole Nesting Cart Base  
Load Rating: 160lbs. | 72.5kg



**PSP-BASE**

Low-Profile Single-Pole Floor Stand  
Load Rating: 100lbs. | 45.3kg



**PSP-S-BASE**

Low-Profile Single-Pole Floor Stand  
Load Rating: 100lbs. | 45.3kg



**LFC-L - LFC-LB**

Large Format Cart for Flat Panels

## POLES\*



**T40**

40" Dual Poles



**T60(Chrome)**  
**T60B(Black)**

60" Dual Poles



**T72(Chrome)**  
**T72B(Black)**

72" Dual-Poles

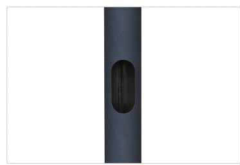

**T84(Chrome)**  
**T84B(Black)**

84" Dual-Poles

**P60(Chrome)**

**P60B(Black)**

60" Single poles

**P72(Chrome)**

**P72B(Black)**

72" Single-Poles

**P84(Chrome)**

**P84B(Black)**

84" Single Poles

\*Weight capacity of poles is based on the weight of the floorstand.

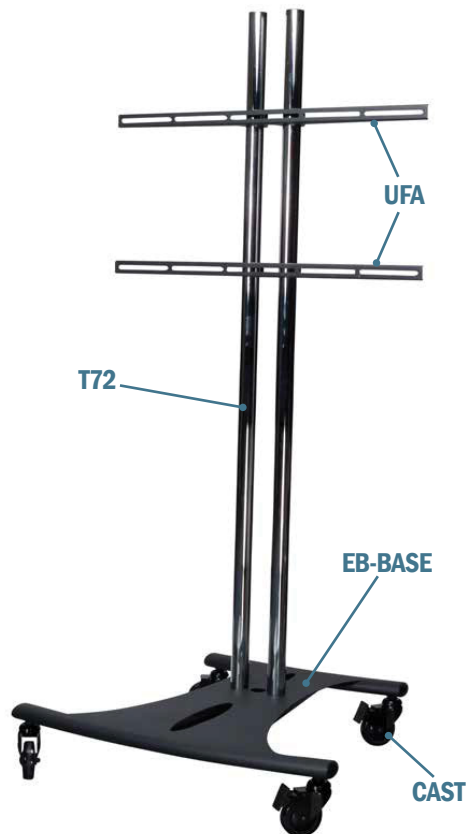

## COMPATIBLE MOUNTS

### TILT MOUNTS\*



**CTM-MS1**

Universal Tilt Mount for Flat Panel Displays with VESA up to 490mm x 360mm



**CTM-MS2**

Universal Tilt Mount for Flat Panel Displays with VESA up to 800mm x 505mm



**CTM-MS3**

Universal Tilt Mount for Flat Panel Displays with VESA up to 900mm x 735mm



**PTM2**

Tilt Mount for Displays with up to 400mm x 400mm VESA pattern

\*Tilt mounts require PSD- HDCA or PSD-DPB to connect to dual-pole stands and PSD-SPA to connect to Single-Pole Stands.

### FLAT MOUNTS



**UFA**

Universal Flat Brackets to Mount Flat Panel Displays up to 160 lbs



**UFA-XL**

Universal Fixed Dual-Pole Mount for Multiple Flat-Panel Display up to 160 lbs



**PFDM2\***

Flat Mount for Displays with up to 400mm x 400mm VESA pattern

\*PFDM2 requires PSD- HDCA or PSD-DPB to connect to dual-pole stands and PSD-SPA to connect to Single-Pole Stands.

### ROTATING MOUNTS



**RTM-S**

Rotating Mount Flat Panel Displays up to 125 lbs.



**RTM-L**

Rotating Mount Flat Panel Displays up to 160 lbs.

## ACCESSORIES

### SHELVES



**PSD-CAM**

Camera Shelf for Dual Pole Carts & Stands



**PSD-SHB**

Accessory Shelf for Dual Pole Carts & Stands



**7170-1004-00**

Two-Piece Camera Shelf for Dual-Pole Carts & Stands



**PSD-SBH**

Brochure Holder for Dual-Pole Carts & Stands

### ADAPTERS



**PSD-HDCA**

Single Display Adapter for Dual Pole Carts & Stands



**PSD-DPB**

Back-to-Back Adapter for CS Series Floor Stands

### CASTERS



**CAST**

4" Casters for Mobile Display Stands



**CAST-BW**

3" Casters for BW-BASE



## 1 SELECT A BASE

Custom to fit your project needs!



## 2 PICK A POLE LENGTH

Choose from different column sizes and finish: 40", 60", 72" and 84".



## 3 CHOOSE A MOUNT

Based on the VESA pattern, display weight and how much tilt & rotation is needed.



## 4 SUPPORT AUXILIARY DEVICES & LITERATURE

Accessorize with an equipment shelf, media player bracket or brochure holder.



## ✓ ALL DONE!

Configured to your specific needs.

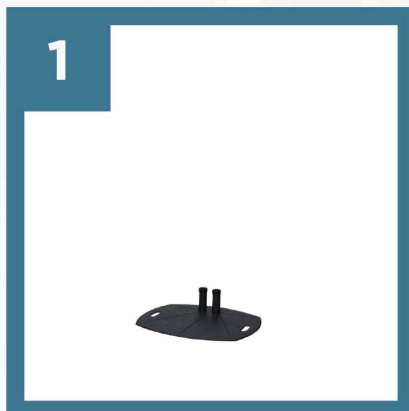

# HOW TO BUY

Contact Your Local Sales Representative!

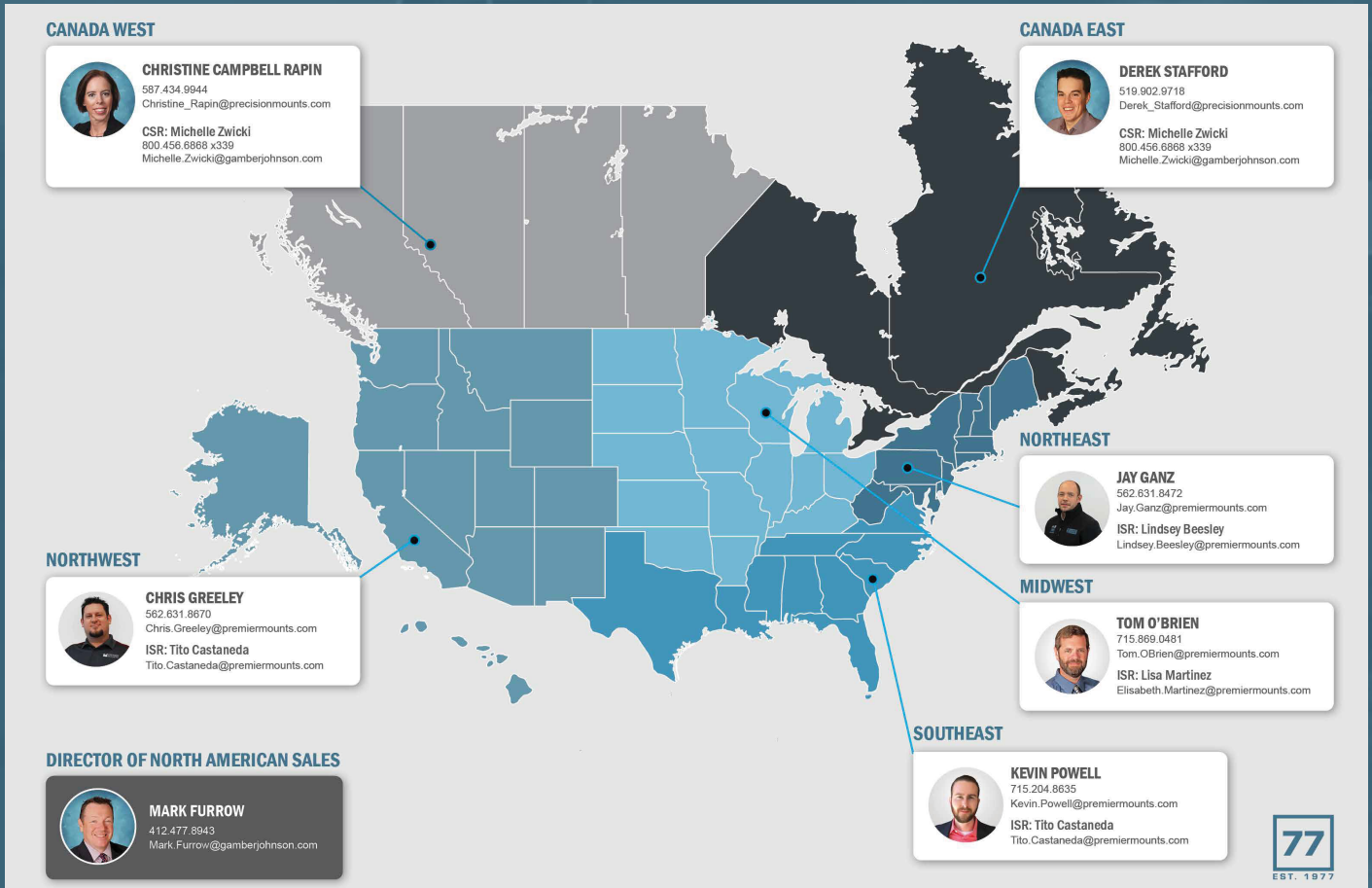

**CANADA WEST**

**CHRISTINE CAMPBELL RAPIN**  
587.434.9944  
Christine\_Rapin@precisionmounts.com  
CSR: Michelle Zwicki  
800.456.6868 x339  
Michelle.Zwicki@gamberjohnson.com

**CANADA EAST**

**DEREK STAFFORD**  
519.802.9718  
Derek\_Stafford@precisionmounts.com  
CSR: Michelle Zwicki  
800.456.6868 x339  
Michelle.Zwicki@gamberjohnson.com

**NORTHWEST**

**CHRIS GREELEY**  
562.631.8670  
Chris.Greeley@premiermounts.com  
ISR: Tito Castaneda  
Tito.Castaneda@premiermounts.com

**NORTHEAST**

**JAY GANZ**  
562.631.8472  
Jay.Ganz@premiermounts.com  
ISR: Lindsey Beesley  
Lindsey.Beesley@premiermounts.com

**MIDWEST**

**TOM O'BRIEN**  
715.869.0481  
Tom.O'Brien@premiermounts.com  
ISR: Lisa Martinez  
Elisabeth.Martinez@premiermounts.com

**SOUTHEAST**

**KEVIN POWELL**  
715.204.8635  
Kevin.Powell@premiermounts.com  
ISR: Tito Castaneda  
Tito.Castaneda@premiermounts.com

**DIRECTOR OF NORTH AMERICAN SALES**

**MARK FURROW**  
412.477.8943  
Mark.Furrow@gamberjohnson.com



**QUESTIONS OR NEED MORE INFORMATION?  
NO PROBLEM, WE'RE HERE TO HELP!**

Call us at **1.800.368.9700** or email us at **ORDERS@PREMIERMOUNTS.COM**

Visit **PREMIERMOUNTS.COM** to see our complete line of pro A/V mounting solutions and hang with us on social media at **@PREMIERMOUNTS**



We look forward to hanging with you and MOUNT UP.

**PREMIER MOUNTS**  
500 W Central Ave, Suite A  
Brea, CA 92821